

# KARTA KATALOGOWA RODZINY PRODUKTÓW LEDVANCE FLOODLIGHT LED

## Naświetlacze LED



### OBSZAR ZASTOSWAŃ

- Parkingi i przejścia podziemne
- Garaże
- Strefy publiczne
- Elewacje budynków
- Tereny budowy

### KORZYŚCI ZE STOSOWANIA PRODUKTU

- Oszczędność energii aż do 90% (w porównaniu z naświetlaczami z lampami halogenowymi)
- Zoptymalizowana masa i rozmiary dzięki kompaktowej konstrukcji
- Bardzo jednorodne światło

### CECHY PRODUKTU

- Skuteczność świetlna oprawy: do 100 lm/W
- Kąt wiązki światła: 100°
- Stopień ochrony: IP65



## DANE TECHNICZNE

| Opis produktu                  | Dane elektryczne              |                |                     |                        |                             | Dane fotometryczne  |                   |                            |                                   |   | Dane świetlne       |
|--------------------------------|-------------------------------|----------------|---------------------|------------------------|-----------------------------|---------------------|-------------------|----------------------------|-----------------------------------|---|---------------------|
|                                | Tryb pracy                    | Moc znamionowa | Napięcie znamionowe | Częstotliwość sieciowa | Współczynnik mocy $\lambda$ | Temperatura barwowa | Strumień świetlny | Barwa światła (oznaczenie) | Ogólny wskaźnik oddawania barw Ra | Standardowe odchylenie dopasowania barw | Kąt rozsyłu światła |
| FLOODLIGHT LED 10 W 3000 K WT  | Electronic control gear (EVG) | 10,00 W        | 220...240 V         | 50/60 Hz               | >0,90                       | 3000 K              | 800 lm            | Warm White                 | ≥80                               | ≤5 sdc                                  | 100,00 °            |
| FLOODLIGHT LED 10 W 4000 K WT  | Electronic control gear (EVG) | 10,00 W        | 220...240 V         | 50/60 Hz               | >0,90                       | 4000 K              | 800 lm            | Cool White                 | ≥80                               | ≤5 sdc                                  | 100,00 °            |
| FLOODLIGHT LED 20 W 3000 K WT  | Electronic control gear (EVG) | 20,00 W        | 220...240 V         | 50/60 Hz               | >0,90                       | 3000 K              | 2000 lm           | Warm White                 | >80                               | ≤5 sdc                                  | 100,00 °            |
| FLOODLIGHT LED 20 W 3000 K BK  | Electronic control gear (EVG) | 20,00 W        | 220...240 V         | 50/60 Hz               | >0,90                       | 3000 K              | 2000 lm           | Warm White                 | >80                               | ≤5 sdc                                  | 100,00 °            |
| FLOODLIGHT LED 20 W 4000 K BK  | Electronic control gear (EVG) | 20,00 W        | 220...240 V         | 50/60 Hz               | >0,90                       | 4000 K              | 2000 lm           | Cool White                 | ≥80                               | ≤5 sdc                                  | 100,00 °            |
| FLOODLIGHT LED 50 W 3000 K WT  | Electronic control gear (EVG) | 50,00 W        | 220...240 V         | 50/60 Hz               | >0,90                       | 3000 K              | 5000 lm           | Warm White                 | >80                               | ≤5 sdc                                  | 100,00 °            |
| FLOODLIGHT LED 50 W 3000 K BK  | Electronic control gear (EVG) | 50,00 W        | 220...240 V         | 50/60 Hz               | >0,90                       | 3000 K              | 5000 lm           | Warm White                 | >80                               | ≤5 sdc                                  | 100,00 °            |
| FLOODLIGHT LED 50 W 4000 K BK  | Electronic control gear (EVG) | 50,00 W        | 220...240 V         | 50/60 Hz               | >0,90                       | 4000 K              | 5000 lm           | Cool White                 | ≥80                               | ≤5 sdc                                  | 100,00 °            |
| FLOODLIGHT LED 100 W 4000 K BK | Electronic control gear (EVG) | 100,00 W       | 220...240 V         | 50/60 Hz               | >0,90                       | 4000 K              | 10000 lm          | Cool White                 | >80                               | ≤5 sdc                                  | 100,00 °            |
| FLOODLIGHT LED 100 W 6500 K BK | Electronic control gear (EVG) | 100,00 W       | 220...240 V         | 50/60 Hz               | >0,90                       | 6500 K              | 10000 lm          | Cool Daylight              | ≥80                               | ≤5 sdc                                  | 100,00 °            |
| FLOODLIGHT LED 150 W 4000 K BK | Electronic control gear (EVG) | 150,00 W       | 220...240 V         | 50/60 Hz               | >0,90                       | 4000 K              | 15000 lm          | Cool White                 | >80                               | ≤5 sdc                                  | 100,00 °            |
| FLOODLIGHT LED 150 W 6500 K BK | Electronic control gear (EVG) | 150,00 W       | 220...240 V         | 50/60 Hz               | >0,90                       | 6500 K              | 15000 lm          | Cool Daylight              | ≥80                               | ≤5 sdc                                  | 100,00 °            |
| FLOODLIGHT LED 200 W 4000 K BK | Electronic control gear (EVG) | 200,00 W       | 220...240 V         | 50/60 Hz               | >0,90                       | 4000 K              | 20000 lm          | Cool White                 | >80                               | ≤5 sdc                                  | 100,00 °            |
| FLOODLIGHT LED 200 W 6500 K BK | Electronic control gear (EVG) | 200,00 W       | 220...240 V         | 50/60 Hz               | >0,90                       | 6500 K              | 20000 lm          | Cool Daylight              | ≥80                               | ≤5 sdc                                  | 100,00 °            |

| Opis produktu                  | Wymiary i waga |           |          | Kolory i materiały |                |                 | Temperatury i warunki pracy  | Trwałość             |                      |
|--------------------------------|----------------|-----------|----------|--------------------|----------------|-----------------|------------------------------|----------------------|----------------------|
|                                | Długość        | Szerokość | Wysokość | Materiał           | Kolor produktu | Materiał osłony | Zakres temperatury otoczenia | Trwałość L70 @ 25 °C | Trwałość L80 @ 25 °C |
| FLOODLIGHT LED 10 W 3000 K WT  | 117,0 mm       | 127,0 mm  | 39,0 mm  | Polycarbonate (PC) | White          |                 | -20...50 °C                  | 50000 h              | 30000 h              |
| FLOODLIGHT LED 10 W 4000 K WT  | 117,0 mm       | 127,0 mm  | 39,0 mm  | Polycarbonate (PC) | White          |                 | -20...50 °C                  | 50000 h              | 30000 h              |
| FLOODLIGHT LED 20 W 3000 K WT  | 155,0 mm       | 167,0 mm  | 44,0 mm  | Polycarbonate (PC) | White          |                 | -20...50 °C                  | 50000 h              | 30000 h              |
| FLOODLIGHT LED 20 W 3000 K BK  | 155,0 mm       | 167,0 mm  | 44,0 mm  | Polycarbonate (PC) | Black          |                 | -20...50 °C                  | 50000 h              | 30000 h              |
| FLOODLIGHT LED 20 W 4000 K BK  | 167,0 mm       | 155,0 mm  | 44,0 mm  | Polycarbonate (PC) | Black          |                 | -20...50 °C                  | 50000 h              | 30000 h              |
| FLOODLIGHT LED 50 W 3000 K WT  | 187,0 mm       | 216,0 mm  | 62,0 mm  | Polycarbonate (PC) | White          |                 | -20...50 °C                  | 50000 h              | 30000 h              |
| FLOODLIGHT LED 50 W 3000 K BK  | 187,0 mm       | 216,0 mm  | 81,0 mm  | Polycarbonate (PC) | Black          |                 | -20...50 °C                  | 50000 h              | 30000 h              |
| FLOODLIGHT LED 50 W 4000 K BK  | 187,0 mm       | 216,0 mm  | 62,0 mm  | Polycarbonate (PC) | Black          |                 | -20...50 °C                  | 50000 h              | 30000 h              |
| FLOODLIGHT LED 100 W 4000 K BK | 243,0 mm       | 253,0 mm  | 93,0 mm  | Aluminum           | Black          |                 | -20...50 °C                  | 50000 h              | 40000 h              |
| FLOODLIGHT LED 100 W 6500 K BK | 253,0 mm       | 243,0 mm  | 92,5 mm  | Aluminum           | Black          | Glass           | -20...50 °C                  | 50000 h              | 40000 h              |
| FLOODLIGHT LED 150 W 4000 K BK | 269,0 mm       | 298,0 mm  | 128,0 mm | Aluminum           | Black          |                 | -20...50 °C                  | 50000 h              | 30000 h              |
| FLOODLIGHT LED 150 W 6500 K BK | 298,0 mm       | 269,0 mm  | 128,0 mm | Aluminum           | Black          | Glass           | -20...50 °C                  | 50000 h              | 40000 h              |
| FLOODLIGHT LED 200 W 4000 K BK | 328,0 mm       | 362,0 mm  | 125,0 mm | Aluminum           | Black          |                 | -20...50 °C                  | 50000 h              | 40000 h              |
| FLOODLIGHT LED 200 W 6500 K BK | 362,0 mm       | 328,0 mm  | 124,0 mm | Aluminum           | Black          | Glass           | -20...50 °C                  | 50000 h              | 40000 h              |

| Opis produktu                  | Trwałość L90 @ 25 °C | Liczba cykli włączeniowych | Możliwości  |               | Certyfikaty i Normy |                    |
|--------------------------------|----------------------|----------------------------|-------------|---------------|---------------------|--------------------|
|                                |                      |                            | Ściemnianie | Typ połączeń  | Klasa ochronności   | Typ zabezpieczenia |
| FLOODLIGHT LED 10 W 3000 K WT  | 15000 h              | 30000                      | Nie         | Cable, 3-pole | I                   | IP65               |
| FLOODLIGHT LED 10 W 4000 K WT  | 15000 h              | 30000                      | Nie         | Cable, 3-pole | I                   | IP65               |
| FLOODLIGHT LED 20 W 3000 K WT  | 15000 h              | 30000                      | Nie         | Cable, 3-pole | I                   | IP65               |
| FLOODLIGHT LED 20 W 3000 K BK  | 15000 h              | 30000                      | Nie         | Cable, 3-pole | I                   | IP65               |
| FLOODLIGHT LED 20 W 4000 K BK  | 15000 h              | 30000                      | Nie         | Cable, 3-pole | I                   | IP65               |
| FLOODLIGHT LED 50 W 3000 K WT  | 15000 h              | 30000                      | Nie         | Cable, 3-pole | I                   | IP65               |
| FLOODLIGHT LED 50 W 3000 K BK  | 15000 h              | 30000                      | Nie         | Cable, 3-pole | I                   | IP65               |
| FLOODLIGHT LED 50 W 4000 K BK  | 15000 h              | 30000                      | Nie         | Cable, 3-pole | I                   | IP65               |
| FLOODLIGHT LED 100 W 4000 K BK | 20000 h              | 30000                      | Nie         | Cable, 3-pole | I                   | IP65               |
| FLOODLIGHT LED 100 W 6500 K BK | 20000 h              | 30000                      | Nie         | Cable, 3-pole | I                   | IP65               |
| FLOODLIGHT LED 150 W 4000 K BK | 15000 h              | 30000                      | Nie         | Cable, 3-pole | I                   | IP65               |

| Opis produktu                  | Trwałość L90 @ 25 °C | Liczba cykli włączeniowych | Możliwości  |               | Certyfikaty i Normy |                    |
|--------------------------------|----------------------|----------------------------|-------------|---------------|---------------------|--------------------|
|                                |                      |                            | Ściemnianie | Typ połączeń  | Klasa ochronności   | Typ zabezpieczenia |
| FLOODLIGHT LED 150 W 6500 K BK | 20000 h              | 30000                      | Nie         | Cable, 3-pole | I                   | IP65               |
| FLOODLIGHT LED 200 W 4000 K BK | 20000 h              | 30000                      | Nie         | Cable, 3-pole | I                   | IP65               |
| FLOODLIGHT LED 200 W 6500 K BK | 20000 h              | 30000                      | Nie         | Cable, 3-pole | I                   | IP65               |

| Opis produktu                  | Normy                  |
|--------------------------------|------------------------|
| FLOODLIGHT LED 10 W 3000 K WT  | CE/CB/TÜV SÜD/EAC/ROHS |
| FLOODLIGHT LED 10 W 4000 K WT  | CE/CB/TÜV SÜD/EAC/ROHS |
| FLOODLIGHT LED 20 W 3000 K WT  | CE/CB/TÜV SÜD/EAC/ROHS |
| FLOODLIGHT LED 20 W 3000 K BK  | CE/CB/TÜV SÜD/EAC/ROHS |
| FLOODLIGHT LED 20 W 4000 K BK  | CE/CB/TÜV SÜD/EAC/ROHS |
| FLOODLIGHT LED 50 W 3000 K WT  | CE/CB/TÜV SÜD/EAC/ROHS |
| FLOODLIGHT LED 50 W 3000 K BK  | CE/CB/TÜV SÜD/EAC/ROHS |
| FLOODLIGHT LED 50 W 4000 K BK  | CE/CB/TÜV SÜD/EAC/ROHS |
| FLOODLIGHT LED 100 W 4000 K BK | CE/CB/TÜV SÜD/EAC/ROHS |
| FLOODLIGHT LED 100 W 6500 K BK | CE/CB/TÜV SÜD/EAC/ROHS |
| FLOODLIGHT LED 150 W 4000 K BK | CE/CB/TÜV SÜD/EAC/ROHS |
| FLOODLIGHT LED 150 W 6500 K BK | CE/CB/TÜV SÜD/EAC/ROHS |
| FLOODLIGHT LED 200 W 4000 K BK | CE/CB/TÜV SÜD/EAC/ROHS |
| FLOODLIGHT LED 200 W 6500 K BK | CB/TÜV SÜD/EAC/ROHS/CE |

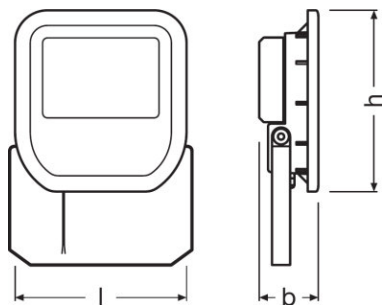

FLOODLIGHT LED 10 W 3000 K WT,  
FLOODLIGHT LED 10 W 4000 K WT

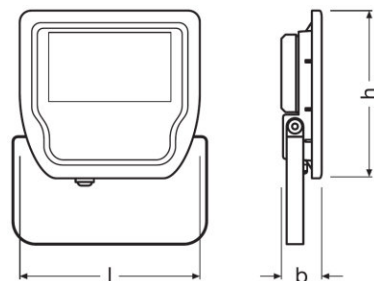

FLOODLIGHT LED 20 W 3000 K WT

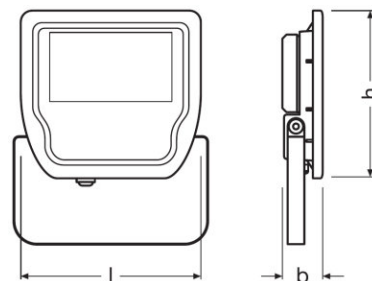

FLOODLIGHT LED 20 W 3000 K BK,  
FLOODLIGHT LED 20 W 4000 K BK

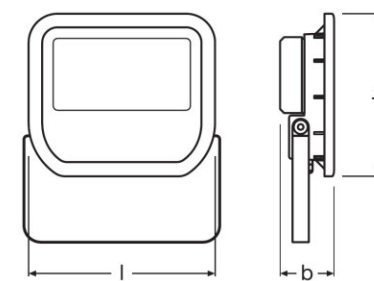

FLOODLIGHT LED 50 W 3000 K WT

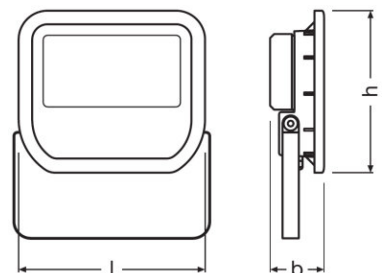

FLOODLIGHT LED 50 W 3000 K BK,  
FLOODLIGHT LED 50 W 4000 K BK

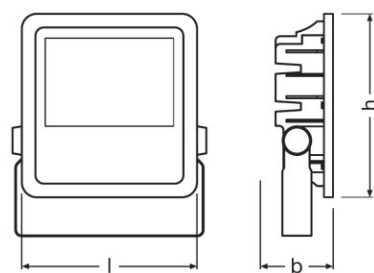

FLOODLIGHT LED 100 W 4000 K BK,  
FLOODLIGHT LED 100 W 6500 K BK

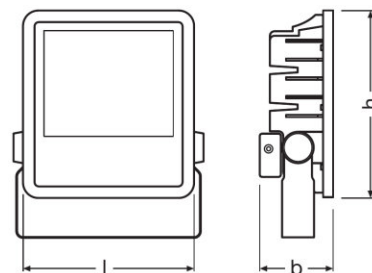

FLOODLIGHT LED 150 W 4000 K BK,  
FLOODLIGHT LED 150 W 6500 K BK

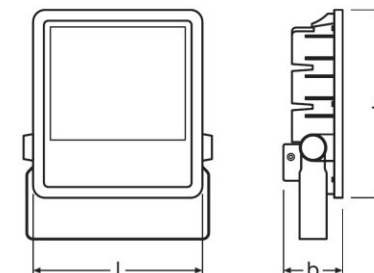

FLOODLIGHT LED 200 W 4000 K BK,  
FLOODLIGHT LED 200 W 6500 K BK

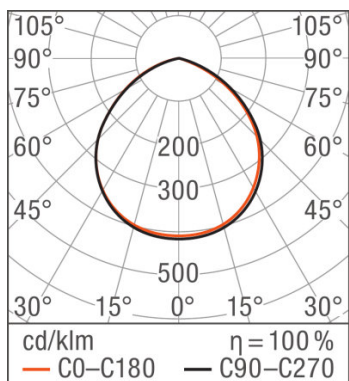

FLOODLIGHT LED 20 W 3000 K WT

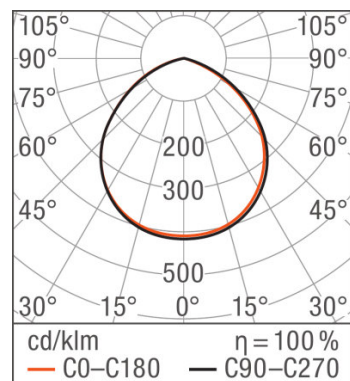

FLOODLIGHT LED 20 W 3000 K BK

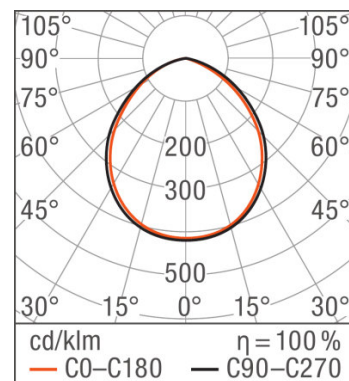

FLOODLIGHT LED 50 W 3000 K WT

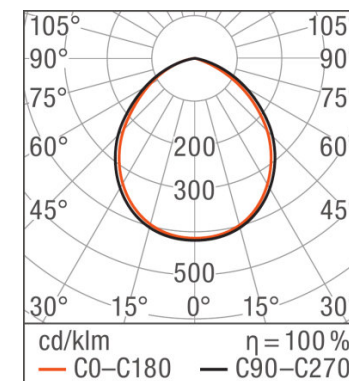

FLOODLIGHT LED 50 W 3000 K BK

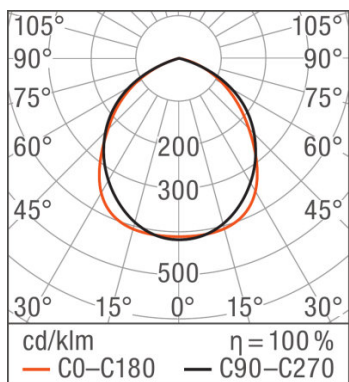

FLOODLIGHT LED 100 W 4000 K BK

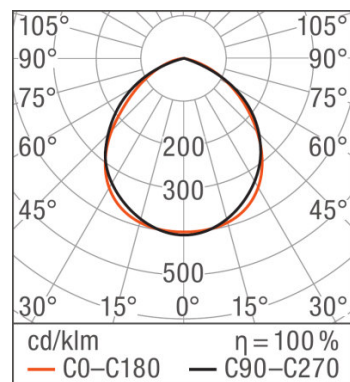

FLOODLIGHT LED 150 W 4000 K BK

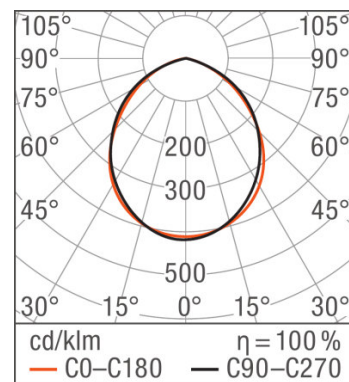

FLOODLIGHT LED 200 W 4000 K BK

### WSKAZÓWKI DOTYCZĄCE ZASTOSOWANIA

Więcej szczegółowych informacji dotyczących grafik i zastosowania znajduje się w karcie katalogowej produktu

## DANE LOGISTYCZNE

| Kod produktu  | Opis produktu                  | Opakowanie (liczba produktów / opakowanie) | Wymiary (długość x szerokość x wysokość) | Objętość              | Waga brutto |
|---------------|--------------------------------|--|--|-----------------------|-------------|
| 4058075810938 | FLOODLIGHT LED 10 W 3000 K WT  | Karton wysylkowy<br>10                     | 280 mm x 248 mm x 210 mm                 | 14.58 dm <sup>3</sup> | 5.00 g      |
| 4058075810952 | FLOODLIGHT LED 10 W 4000 K WT  | Karton wysylkowy<br>10                     | 280 mm x 248 mm x 210 mm                 | 14.58 dm <sup>3</sup> | 5.00 g      |
| 4058075001084 | FLOODLIGHT LED 20 W 3000 K WT  | Karton wysylkowy<br>28                     | 419 mm x 392 mm x 430 mm                 | 70.63 dm <sup>3</sup> | 20247.00 g  |
| 4058075001060 | FLOODLIGHT LED 20 W 3000 K BK  | Karton wysylkowy<br>28                     | 419 mm x 392 mm x 430 mm                 | 70.63 dm <sup>3</sup> | 20247.00 g  |
| 4058075810976 | FLOODLIGHT LED 20 W 4000 K BK  | Karton wysylkowy<br>10                     | 384 mm x 298 mm x 220 mm                 | 25.18 dm <sup>3</sup> | 8.72 g      |
| 4058075001145 | FLOODLIGHT LED 50 W 3000 K WT  | Karton wysylkowy<br>24                     | 491 mm x 421 mm x 459 mm                 | 94.88 dm <sup>3</sup> | 25456.00 g  |
| 4058075001107 | FLOODLIGHT LED 50 W 3000 K BK  | Karton wysylkowy<br>24                     | 491 mm x 421 mm x 459 mm                 | 94.88 dm <sup>3</sup> | 34346.00 g  |
| 4058075810990 | FLOODLIGHT LED 50 W 4000 K BK  | Karton wysylkowy<br>10                     | 482 mm x 348 mm x 232 mm                 | 38.91 dm <sup>3</sup> | 14.21 g     |
| 4058075001138 | FLOODLIGHT LED 100 W 4000 K BK | Karton wysylkowy<br>1                      | 328 mm x 295 mm x 162 mm                 | 15.68 dm <sup>3</sup> | 4077.00 g   |
| 4058075811010 | FLOODLIGHT LED 100 W 6500 K BK | Karton wysylkowy<br>1                      | 328 mm x 295 mm x 162 mm                 | 15.68 dm <sup>3</sup> | 4192.00 g   |
| 4058075001176 | FLOODLIGHT LED 150 W 4000 K BK | Karton wysylkowy<br>1                      | 378 mm x 323 mm x 172 mm                 | 21.00 dm <sup>3</sup> | 5739.00 g   |
| 4058075811027 | FLOODLIGHT LED 150 W 6500 K BK | Karton wysylkowy<br>1                      | 378 mm x 323 mm x 172 mm                 | 21.00 dm <sup>3</sup> | 5866.00 g   |
| 4058075001190 | FLOODLIGHT LED 200 W 4000 K BK | Karton wysylkowy<br>1                      | 455 mm x 390 mm x 167 mm                 | 29.63 dm <sup>3</sup> | 7810.00 g   |
| 4058075811034 | FLOODLIGHT LED 200 W 6500 K BK | Karton wysylkowy<br>1                      | 455 mm x 390 mm x 167 mm                 | 29.63 dm <sup>3</sup> | 7532.00 g   |

Wymieniony kod produktu oznacza najmniejszą ilość produktu, jaka może być zamówiona. Jednostka transportowa może zawierać jedną sztukę lub więcej. Składając zamówienie prosimy o zamawianie ilości odpowiadających jednej lub wielokrotności jednostki transportowej.

## OŚWIADCZENIE

Zastrzega się możliwość zmian bez uprzedzenia. Błędy i ominięcia są możliwe. Należy zawsze upewnić się czy korzystasz z najnowszej wersji katalogu.